

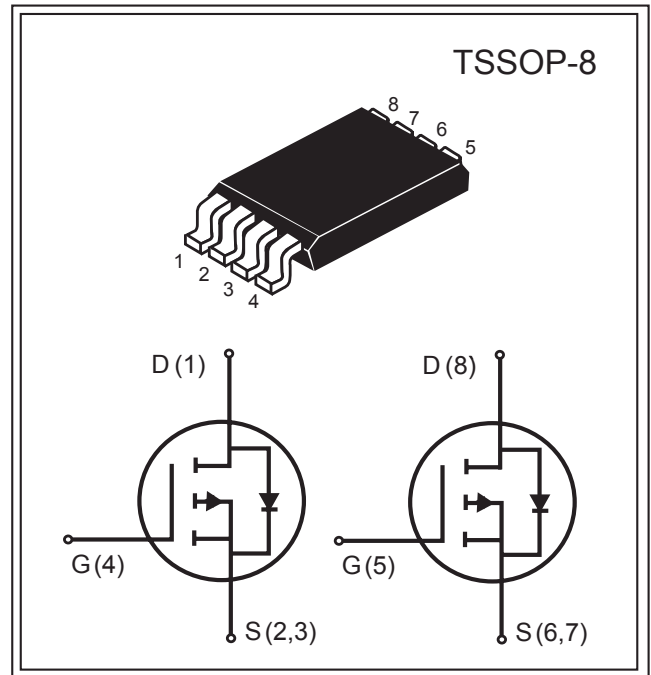

Product Summary		
V _{DS} (V)	I _D (A)	R _{DS(ON)} (mΩ) Max
-20V	-4.5A	55 @V _{GS} = -4.5V
		85 @V _{GS} = -2.5V
		160 @V _{GS} = -1.8V

FEATURES

- ◆ Super high density cell design for low R_{DS(ON)}.
- ◆ Rugged and reliable.
- ◆ TSSOP-8 package.
- ◆ Pb free.



ABSOLUTE MAXIMUM RATINGS (T _A = 25°C unless otherwise noted)			
Parameter	Symbol	Limit	Unit
Drain-Source Voltage	V _{DS}	-20	V
Gate-Source Voltage	V _{GS}	±10	V
Drain Current-Continuous @ T _J = 125°C	I _D	-4.5	A
-Pulsed ^b	I _{DM}	-20	A
Drain-Source Diode Forward Current ^a	I _S	-1.5	A
Maximum Power Dissipation ^a	P _D	1.5	W
Operating Junction and Storage Temperature Range	T _J , T _{STG}	-55 to 150	°C
THERMAL CHARACTERISTICS			
Thermal Resistance, Junction-to-Ambient ^a	R _{θJA}	85	°C/W

South Sea Semiconductor reserves the right to make changes to improve reliability or manufacturability without advance notice.

South Sea Semiconductor, February 2008 (Rev 1.0)



P-Channel Electrical Characteristics (TA = 25°C unless otherwise noted)						
Parameter	Symbol	Condition	Min	Typ ^c	Max	Unit
Drain-Source Breakdown Voltage	BV _{DSS}	V _{GS} =0V, I _D =-250 μA	-20			V
Zero Gate Voltage Drain Current	I _{DSS}	V _{DS} =-16V, V _{GS} =0V			-1	μA
Gate-Body Leakage	I _{GSS}	V _{GS} =±8V, V _{DS} =0V			±100	nA
Gate Threshold Voltage	V _{GS(th)}	V _{DS} =V _{GS} I _D =-250 μA	-0.4		-1.0	V
Drain-Source On-State Resistance	R _{DS(ON)}	V _{GS} =-4.5V, I _D =-4.5A		48	55	mΩ
		V _{GS} =-2.5V, I _D =-2.0A		77	85	
		V _{GS} =-1.8V, I _D =-1.0A			160	
On-State Drain Current	I _{D(ON)}	V _{DS} =-5V, V _{GS} =-4.5V	-6			A
Forward Transconductance	g _{FS}	V _{DS} =-5V, I _D =-4A		7		S
Input Capacitance	C _{ISS}	V _{DS} =-6V		720		pF
Output Capacitance	C _{OSS}	V _{GS} =0V		175		
Reverse Transfer Capacitance	C _{RSS}	f=1.0MHz		125		
Turn-On Delay Time	t _{D(ON)}	V _{DD} =-6V,		15		ns
Rise Time	t _r	I _D =-1A,		35		
Turn-Off Delay Time	t _{D(OFF)}	V _{GEN} =-4.5V,		60		
Fall Time	t _f	R _{GEN} =6Ω,		40		
Total Gate Charge	Q _g	V _{DS} =-6V,		8		nC
Gate-Source Charge	Q _{gs}	I _D =-3.4A,		1.2		
Gate-Drain Charge	Q _{gd}	V _{GS} =-4.5V		2.2		
Diode Forward Voltage	V _{SD}	V _{GS} =0V, I _D =-1A		-0.8	-1.2	V

Notes :

- a. Surface Mounted on FR4 Board, t ≤ 10 sec.
- b. Pulse Test : Pulse Width ≤ 300 μs, Duty Cycle ≤ 2%.
- c. Guaranteed by design, not subject to production testing.

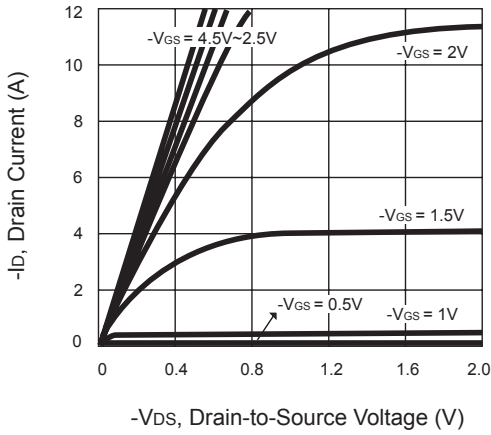

Figure 1. Output Characteristics

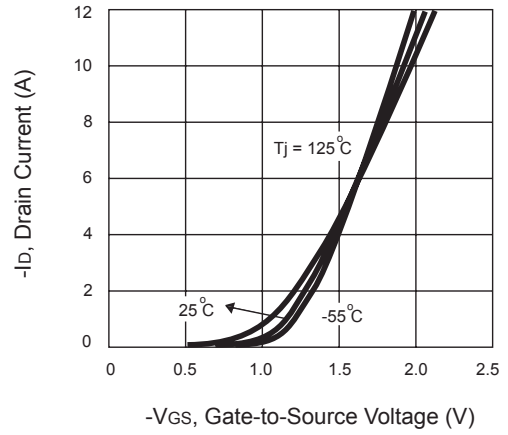

Figure 2. Transfer Characteristics

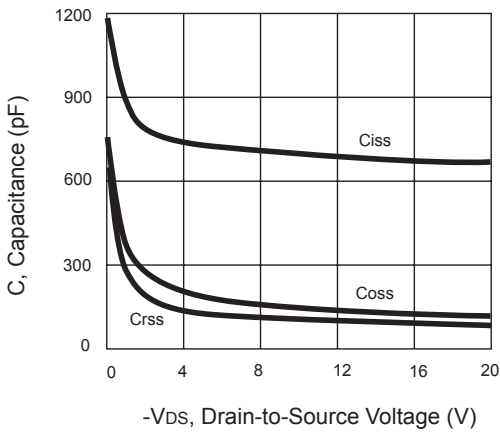

Figure 3. Capacitance

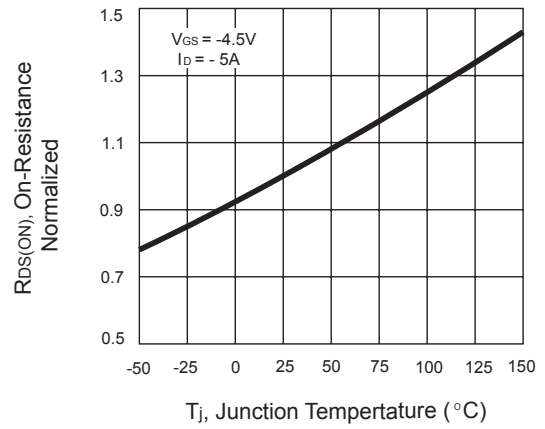

Figure 4. On-Resistance Variation with Temperature

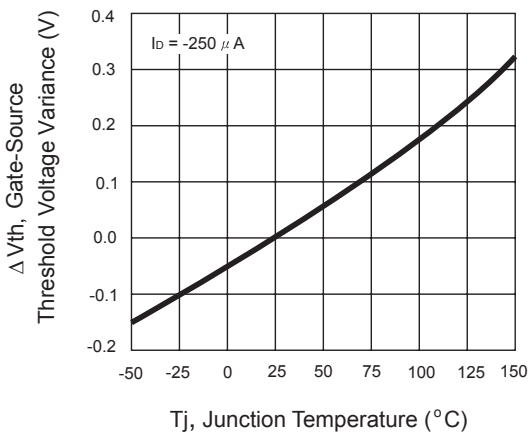

Figure 5. Gate Threshold Variation with Temperature

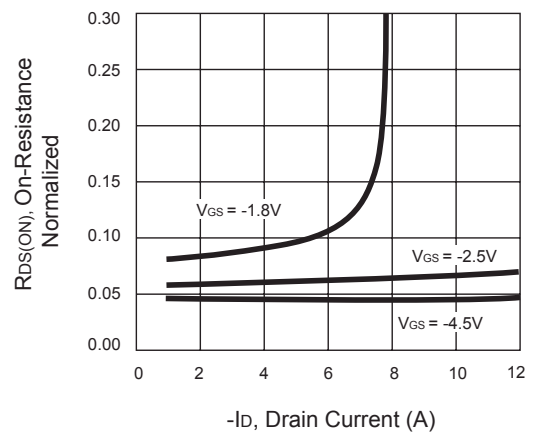

Figure 6. On-Resistance Variation with Drain Current

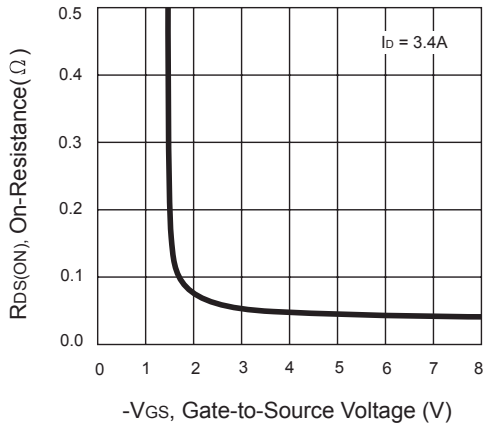

Figure 7. On-Resistance Variation with Gate-to-Source Voltage

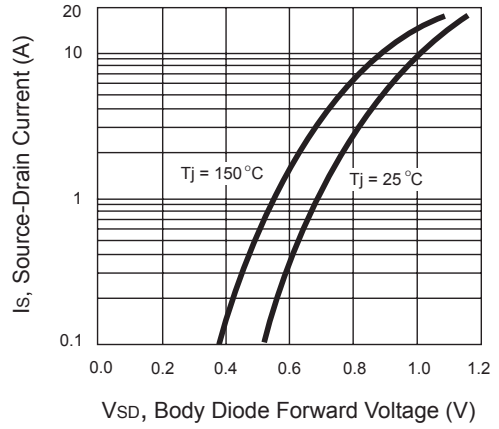

Figure 8. Body Diode Forward Voltage Variation with Source Current

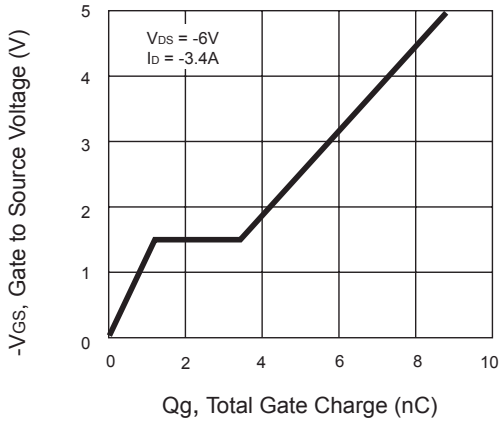

Figure 9. Gate Charge

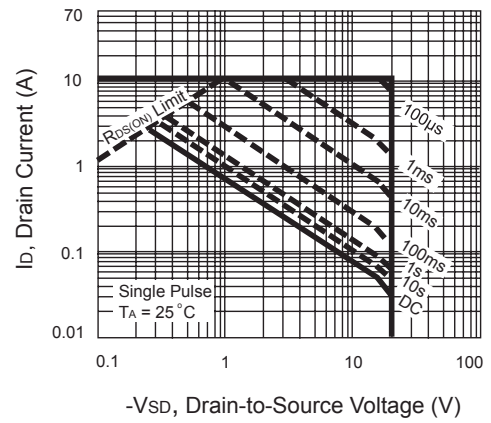

Figure 10. Maximum Safe Operating Area

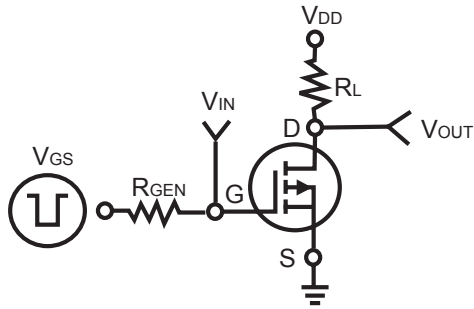

Figure 11. Switching Test Circuit

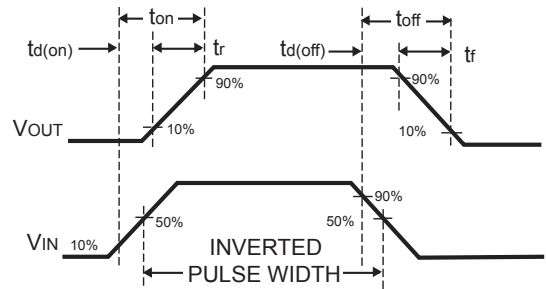

Figure 12. Switching Waveforms

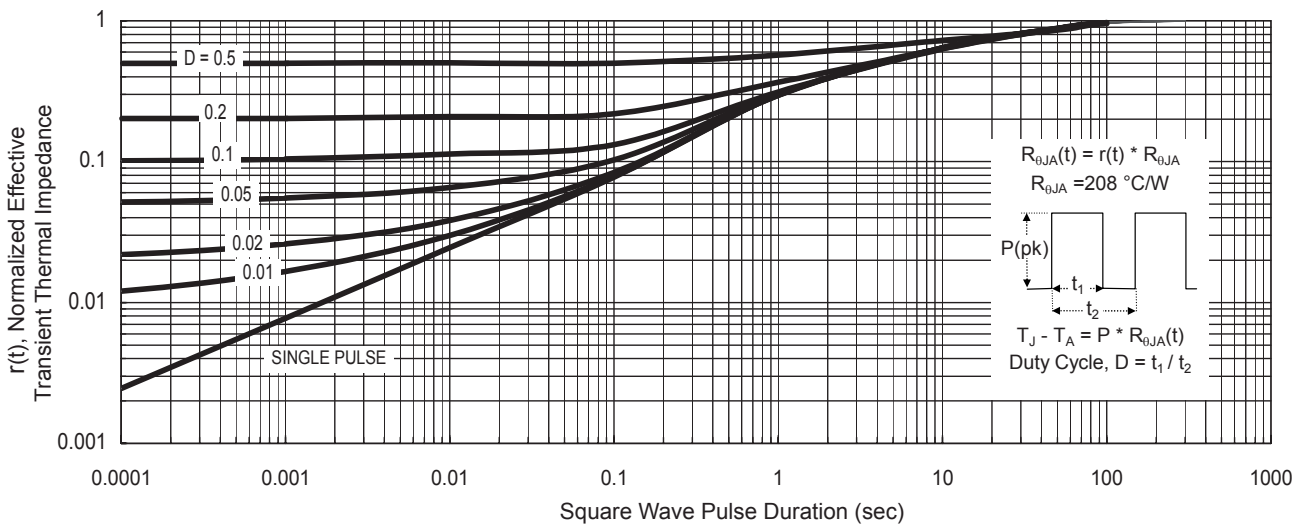

Figure 13. Normalized Thermal Transient Impedance Curve